

Investigation of the Fixed Pattern in Raw IUE Images as a Fiducial for the Geometric Correction

Michele D. De La Peña
IUE Observatory
Computer Sciences Corporation
Astronomy Programs

I Introduction

Results presented in this analysis address the possibility of utilizing the “fixed pattern” detected in raw International Ultraviolet Explorer (IUE) images as a fiducial leading to an improved geometric correction. The fixed pattern is a manifestation of the inherent variations in sensitivity from pixel-to-pixel over the faceplate of the camera. If the fixed pattern is persistent and reliable over the lifetime of the IUE data, a more closely spaced grid of points may be used to map from the raw, distorted space of the Vidicon camera to, for example, a rectilinear, orthogonal space. As a direct consequence, this will lead to a more accurate pixel-to-pixel photometric correction through the improved registration of the Intensity Transfer Function (ITF) with the raw data. Ultimately, this will provide a higher quality data product for scientific analysis.

Linde and Dravins (1988) of the Lund Observatory in Sweden have performed a similar investigation over limited regions of the LWR camera. This analysis, though broader in scope, follows their general approach.

II Analytical Tools

The current algorithm employs a pattern matching technique which relies heavily upon the linear cross correlation function to identify similar patterns in different images. The pattern matching portion of the algorithm is the crucial step in evaluating whether the fixed pattern in raw IUE images can be used as a practical fiducial. Therefore it is necessary to understand fully the strengths and limitations of the cross correlation technique.

In brief, the fundamental idea behind the use of the cross correlation is to compare regions from both a raw image and a geometrically corrected image for distinctive patterns. A portion of the background in a raw IUE image is chosen for comparison. This selected portion is the *template* and contains fixed pattern. A portion or *window* of the geometrically

corrected image corresponding to the *template* through the geometric mapping function is extracted for analysis. This allows the template to search the window for the best correlation. This assumes that the current geometric mapping is sufficiently accurate so that the fixed pattern found in the template can also be found in the window if, indeed, the pattern is present in the geometrically corrected image.

a) *The Linear Cross Correlation Coefficient*

The cross correlation coefficient is defined as

$$r(m, n) = \frac{\sum_x \sum_y (w(x, y) - \overline{w(x, y)})(t(x - m, y - n) - \bar{t})}{(\sum_x \sum_y (w(x, y) - \overline{w(x, y)})^2 \sum_x \sum_y (t(x - m, y - n) - \bar{t})^2)^{1/2}} \quad (1)$$

where $-1.0 \leq r \leq +1.0$. In this equation, \bar{t} is the average value of the template, $\overline{w(x, y)}$ is the average value of the portion of the window which is currently coincident with the template $t(x, y)$, the line coordinate $m = 0, 1, 2, \dots, (L - 1)$, and the sample coordinate $n = 0, 1, 2, \dots, (S - 1)$. For the purposes of this study, $L = 17$ and $S = 15$; these are the dimensions of the sample window. The template dimensions are 7 by 9 pixels. Summations are done over the coordinates common to both w and t .

The coefficient r is a representation of the extent to which two distributions conform to a straight line. A value of $r = +1.0$ denotes a perfect positive correlation; $r = -1.0$ denotes a perfect negative correlation; and $r = 0$ denotes no correlation. Through examination of the above equation one can see if $w(x, y) = t(x - m, y - n)$, then $r = +1.0$ or -1.0 . The positive or negative sign on the coefficient is a reflection of the slope of the best fit line to the data. If $w(x, y)$ and $t(x, y)$ are not similar (not correlated), then for any value of $t(x - m, y - n)$, the expression of $(w(x, y) - \overline{w(x, y)})$ has a equal chance of being positive or negative. In the limit as the number of data points increases for this example of dissimilar distributions, $r(m, n)$ will tend toward zero. The values of $+1.0$, -1.0 , and 0.0 are the theoretical limits of the function, and will probably not be achieved in practice. Figure 1 displays the sampling technique used by the template/window arrangement.

Since the correlation coefficient describes the *extent* to which two distributions fit a straight line, values *close* to $+1.0$ or -1.0 indicate more believable correlations, and values *close* to 0.0 indicate a lack of a convincing correlation. A discussion of an objective method of evaluating the linear cross correlation coefficient (i.e. what is meant by the word *close*) follows in the next section.

b) *Probability Distribution*

It is extremely important to understand how to evaluate properly the meaning of the cross correlation coefficient. The correlation coefficient can be used as a general indicator, but one should avoid putting too much credence into a quantity which is not designed to be used as a pattern matching indicator for *unknown* distributions.

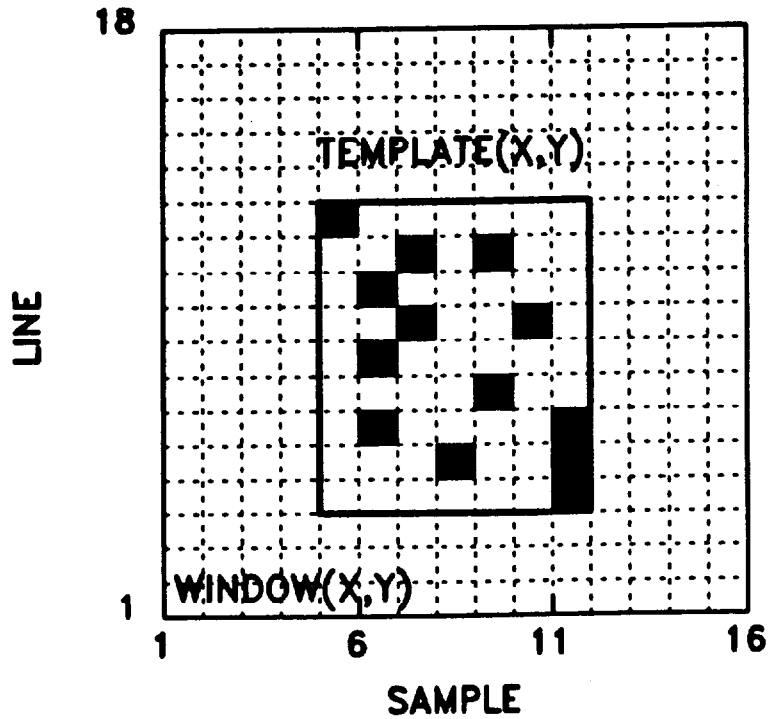

Figure 1: Pattern matching arrangement for obtaining a correlation coefficient matrix for the template search through the window. As a consequence of the sizes of the template and window used in this study, a total of 81 (9x9 matrix) positions are sampled at integer intervals.

If two distributions are known *a priori* to be correlated, then the cross correlation coefficient is the conventional way to describe the strength of the correlation. However, the correlation coefficient itself is *not* a sufficient indicator for determining whether an apparent correlation is statistically significant. There must be a supplemental mechanism for evaluating the correlation coefficient and determining whether a genuine pattern match has been detected. In this analysis, the probability distribution is the mechanism for determining the qualitative significance of the correlation coefficients. This distribution is often tabulated and can be found in most error analysis books (e.g. Taylor 1982). Essentially, the probability distribution, which is a function of *both* the cross correlation coefficient *and* the number of points used to compute the coefficient, relates how probable it is for two variables to be uncorrelated based upon the input data. Small values computed for the probability distribution imply the variables are likely to be correlated. The probability distribution is an objective way to decide what it means to be sufficiently *close* to +1.0 (a correlation).

Basically, it is incorrect and inconsistent to arbitrarily set a threshold of acceptability on the cross correlation coefficient itself. Spuriously high or low values will statistically be achieved. Knowing the number of data points upon which the coefficient has been derived provides a critical piece of data as to the reliability of the measurement. Intuitively, if an $r = 0.9$ is derived based upon only three data points, there is a large probability of this being a spurious correlation. If an $r = 0.9$ is computed based upon 100 data values, there is a higher level of confidence that this is a genuine correlation. Conversely, if an $r = 0.3$ is

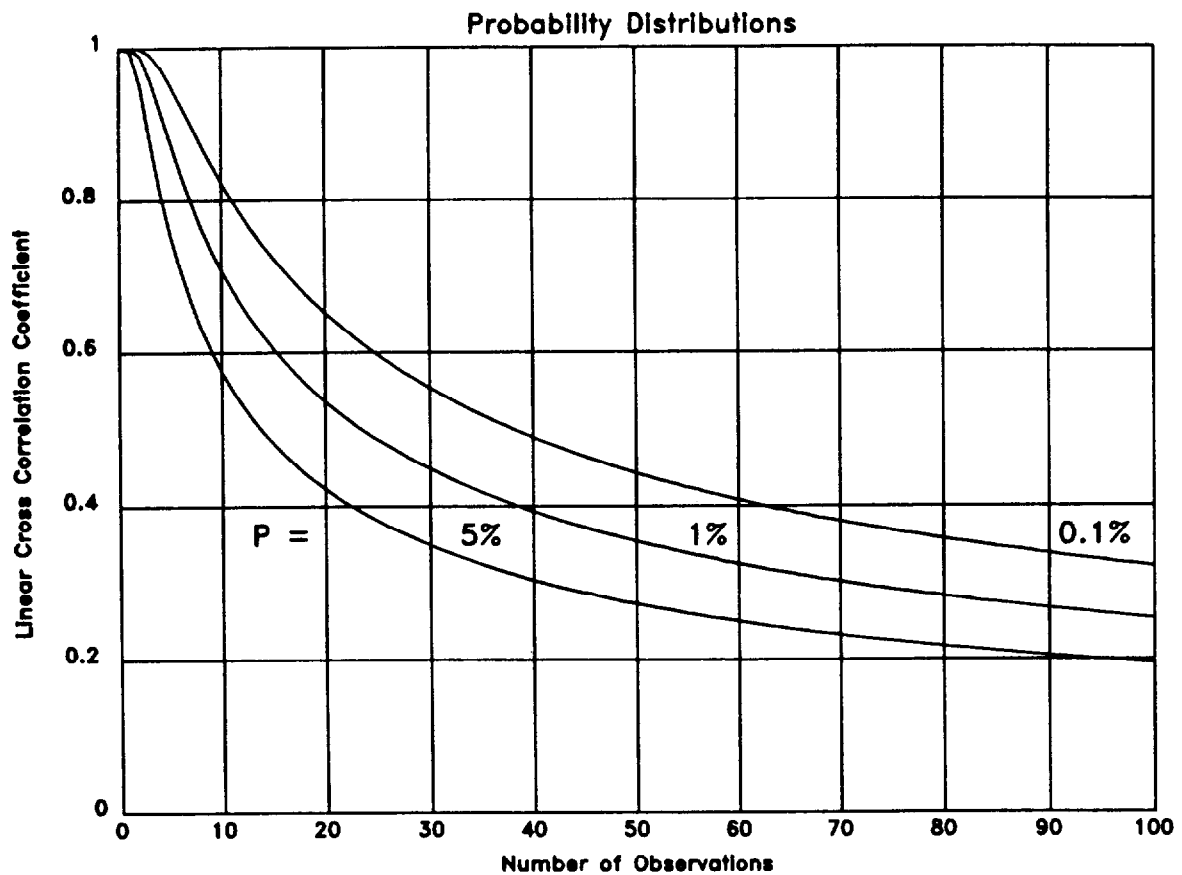

Figure 2: Probability Distributions. Rejection of the null hypothesis: the probability P of obtaining $|r| > \text{some observed value}$ when no real correlation exists.

derived based upon 100 data values, it has a high probability of being a genuine correlation, albeit weak, despite a subjective assessment that it is a low correlation coefficient. Finally, an $r = 0.3$ based upon only three data values is not a probable correlation. Figure 2 depicts various percentage probability levels of the probability distribution.

c) Pattern Matching Tests

A series of pattern matching tests were performed in order to determine how well the cross correlation function could detect specific patterns. These tests consisted of a pattern being imposed upon a mean background level containing gaussian distributed noise.

Table 1: Results of the Null Pattern Tests.

Probability Level (%)	Percent of Spurious Correlations
5.0	4.0
1.0	1.0
0.1	0.1

i Null Tests

The null tests were the comparisons of arrays which contained no known patterns. A series of 1000 sets of randomly generated numbers were compared. Each set consisted of two 7x9 arrays (pixels) which were created using two distinct random number generators. The arrays were then cross correlated, and the resulting coefficient was evaluated at three percentage probabilities: 5%, 1%, and 0.1%; these percentage probabilities can also be thought of as the confidence levels of 95%, 99%, and 99.9% respectively. Results of this series of 1000 tests are shown in Table 1 which displays the percentage of spurious correlations that were found at each probability level.

Additionally, these same tests were performed using actual IUE flat field data as the samples. Dissimilar portions of the IUE image were extracted, and cross correlating these samples of 7x9 pixels gave approximately the same null statistics as shown in Table 1.

ii Pattern Tests

In order to determine how sensitive the cross correlation function is to spatial patterns, tests were performed in which specific patterns of varying intensity were imposed upon two sets of background information; the data sets were then cross correlated. Since it was not evident if one type of pattern could be more readily detected than another, two patterns were chosen for testing purposes, a cross and an irregular shape. The two patterns are shown in Figure 3. Although the test patterns are fairly different in character (the cross being a continuous and distinctive form, and the other being an irregular pattern), the ability of the cross correlation to detect these two patterns was about the same. Henceforth, only the cross pattern will be referenced though all tests were performed on both of the patterns.

As in the case of the null tests, a series of 1000 sets of randomly generated arrays were created (2000 total arrays of 7x9 pixels of randomly generated values). Each array was created at a specified mean level and superimposed with random gaussian noise. For each of the 1000 sets, the same pattern was imposed on both arrays. Specifically, the pattern was created at a certain intensity level; the computed pattern values were then added to the current values in the pixels which were to be overlaid with the pattern. Please see

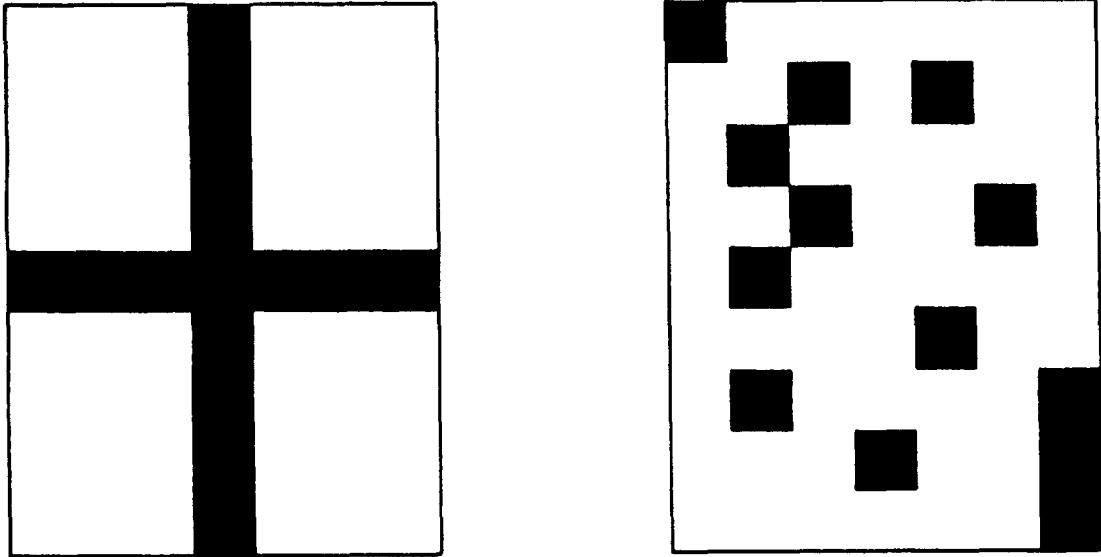

Figure 3: Test Patterns – Cross and Irregular. White indicates a pixel value of zero, and black is indicative of a value greater than zero. All the pixels denoted in black contain the same value for any particular test.

Figure 4 for an illustration of this process.

The two arrays (Array-1 and Array-2) were cross correlated, and the coefficients were evaluated at three percentage probabilities (5%, 1%, and 0.1%) or the corresponding confidence levels (95%, 99%, and 99.9%, respectively). The series of 1000 cross correlations were performed nine times; each time the intensity of the pattern was increased by adding 1/2 times the random noise level to the pattern intensity level of the previous sequence. Figure 5 displays the results of these tests. The background intensity of Array-1 is 120 digital numbers (DN) and of Array-2 is 160 DN. The root mean square of the gaussian noise of Array-1 is 10.95 and of Array-2 is 12.65. For these tests the pattern ranged in intensity from 0 DN in the initial test to 44 DN in the final test. The stronger the intensity of the pattern, the more readily a genuine correlation can be found.

These same tests were performed using IUE flat field data as the general arrays. Different portions of a flat field image were extracted (7x9 pixels), and patterns were imposed upon this information. Figure 6 displays the results of these tests. For the IUE background tests, the background intensity of Array-1 and Array-2 is ~127 DN. The root mean square of the gaussian noise of the data arrays is 11.27. The pattern ranged in intensity from 0 DN in the initial test to 34 DN in the final test. For any given intensity or DN level, the percentage of correlations detected was less in the case of using the IUE flat field information as the general arrays, in contrast to using randomly generated arrays with normally distributed noise. This may be because the noise in the IUE data is other than pure gaussian noise. The noise clearly makes it more difficult for the cross correlation to detect accurately true matches.

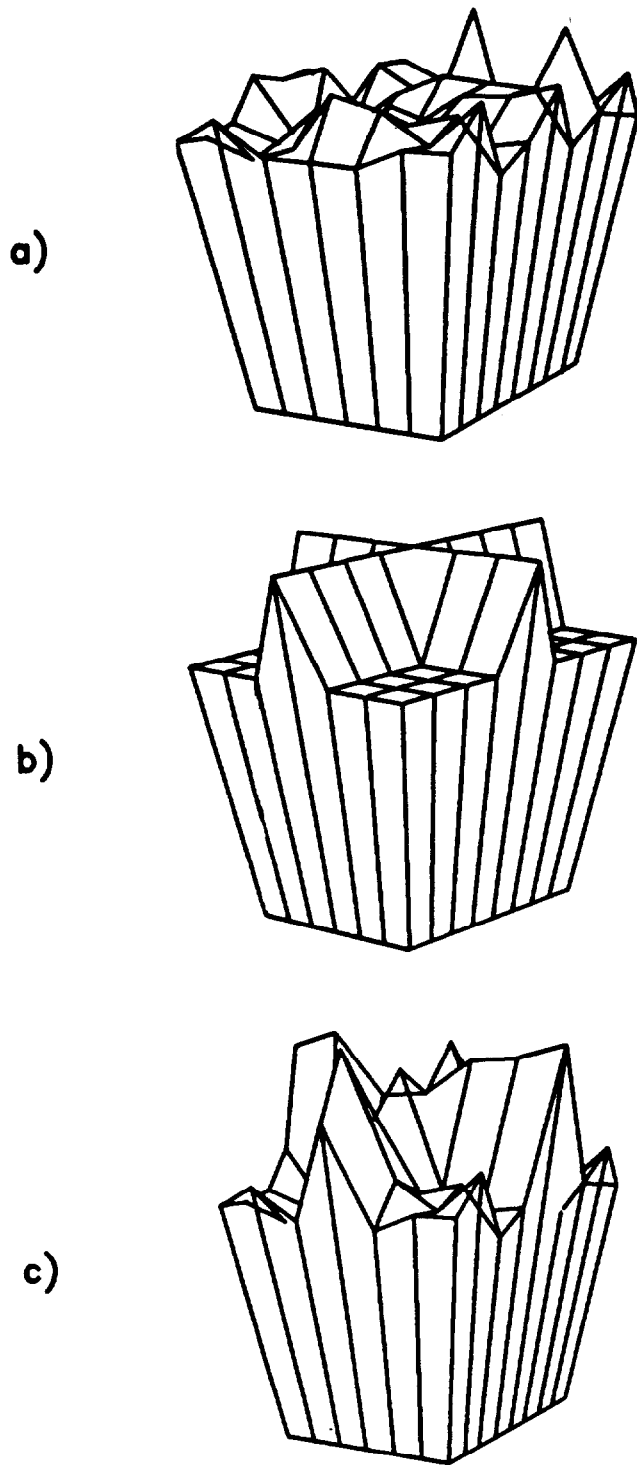

Figure 4: Construction of the pattern superimposed upon background data: a) 7x9 pixel array (mean DN 120) with gaussian noise $\sigma = 10.95$, b) the constructed cross pattern (the background intensity is 0 DN and the pattern intensity is greater than 1 DN, and c) the results of superimposing the second upon the first.

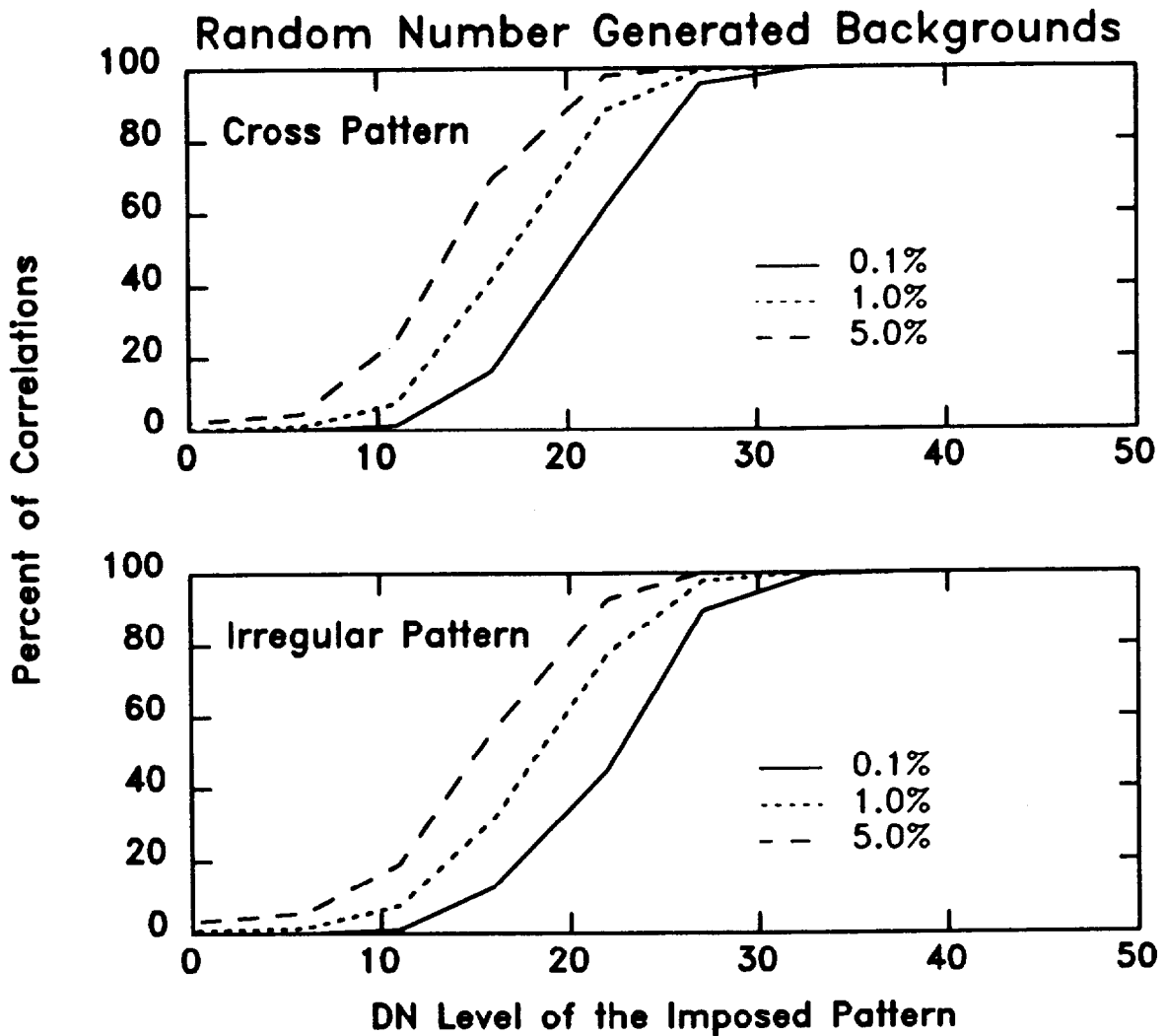

Figure 5: Percentage of Pattern Detections with Random Number Backgrounds. The x-axis represents the intensity of the imposed pattern in digital numbers (DNs). Therefore, the zero on the x-axis means the intensity of the pattern is at the same level as the background. The y-axis represents the percentage of successful cross correlations detected according to the probability criterion. Each curve stands for a different percentage probability level, as shown in the legend. Data Array-1 had a mean DN of 120; the RMS DN of the noise is 10.95; the intensity of the imposed pattern ranges from 0 to 44 DN through the series of tests.

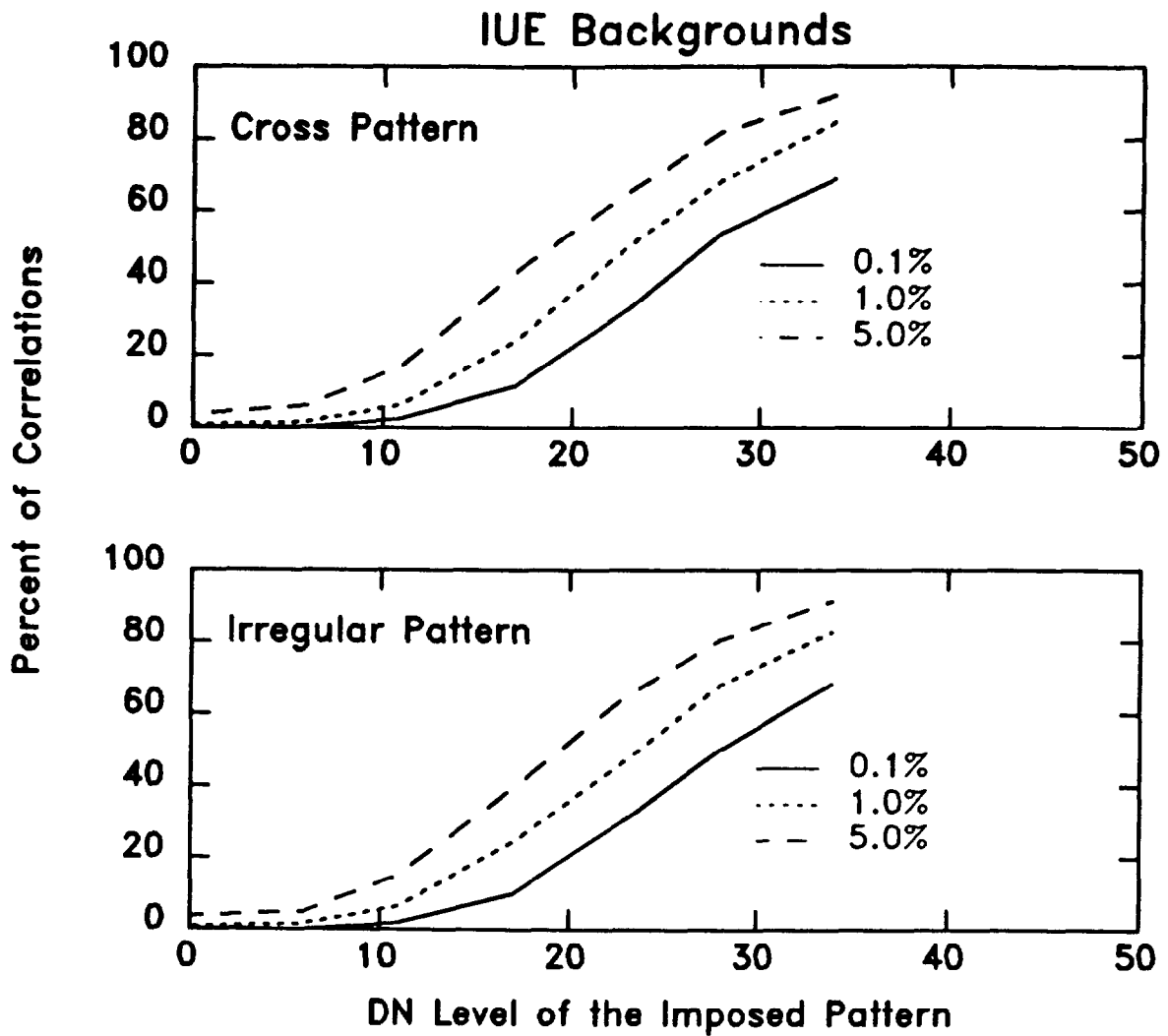

Figure 6: Percentage of Pattern Detections with IUE Flat Field Backgrounds. The description of this plot is the same as for Figure 5. The data arrays had a mean DN of 127; the RMS DN of the noise is 11.27; the intensity of the imposed pattern ranges from 0 to 34 DN through the series of tests.

In both Figures 5 and 6, for a specific DN level in the pattern, the percentage of correlations is higher if a looser criterion for the percentage probability level is used (recall the pattern is actually present 100% of the time). However, the looser the constraint on the probability level, the more spurious matches will be found. These spurious matches are clearly seen at $x = 0$ (there is no pattern imposed here – only background information) where at the 5% probability level several correlations which are *known* to be spurious are detected. Ideally, one would like to minimize the number of spurious correlations from the outset of the investigation, and this requires using a tighter criterion on the percentage probability. However, due to statistics a certain percentage of spurious correlations will arise *regardless* of how stringent the probability criterion, and therefore, under any conditions supplemental criteria will need to be used to eliminate the spurious correlations. Moreover, a looser constraint will allow for the utilization of more genuine correlations. Hence, the solution is to choose the probability criterion which allows the optimum retention of the genuine correlations since spurious correlations will have to be dealt with under any conditions. For this analysis, $\sim 3\sigma$ criterion has been chosen as the probability distribution threshold. This means that the probability computed for the correlation coefficient in question must be less than 1%.

III Pattern Matching Algorithm

The present investigation was motivated by work done by Linde and Dravins (1988) on a select region of LWR images. The algorithm is similar to theirs, but is more general in that it can be applied to the entire target area of all IUE images. The following presents the main procedures of the pattern matching algorithm.

1. Each raw spectral image must be compared to the appropriate level from the ITF image. The mean DN level of the ITF should be approximately the same as the mean background level of the spectral image. One might expect the character of the fixed pattern to change as the intensity increases since the pattern results from the spatial variation in the sensitivity of the pixels in the local region. Preliminary intensity tests have shown as the intensity level of the ITF image diverges from that of the template sample, the failure rate of the pattern matching algorithm increases. The ITF images are used for the source of the window samples as they are easily accessible during standard processing and as they are additions of several images. Having been constructed through the addition of several images, the noise has been reduced relative to the signal in the ITF, thereby making the possibility of a successful pattern match easier.
2. The inter-order regions of the spectral images are accurately determined in geometrically corrected space through the use of the dispersion relations which relate spectral order and wavelength to line and sample. This position is the central point for a 15x17 pixel search window.

3. The corresponding position in the raw, flat field image is computed using the current geometric-to-raw mapping equations as implemented in the IUE Spectral Image Processing System (IUESIPS). Consequently, the template can be optimally positioned between the high dispersion orders. At this time each template is a standard size of 7x9 pixels.
4. Any reseaux, hot spots, cosmic ray hits, and overlapping spectra are removed from the template before the analysis. This is done to insure the cross correlation only uses the fixed pattern and is not influenced by transitory or unreliable artifacts. In order to define the DN bounds for the reliable data, a much larger box (50x50 pixels) in the immediate area of the spectral sample is extracted. Coordinates for the pure inter-order regions have already been computed in Step 3; these coordinates are used to define a swath of background data which has been chosen to be three pixels wide. The mean of these background points is used as the background level in the template sample. Upper and lower DN limits are defined as three times the square root of the mean background value; any data in the template which are outside of this range are removed.
5. The template is sequentially positioned throughout the window, and at each position a linear cross correlation is performed. For each position a correlation coefficient and the coordinates in geometrically corrected space are saved. This allows for a direct comparison of the coordinates computed according to the pattern matching algorithm to the coordinates computed according to the current IUESIPS processing.
6. By virtue of the sizes of the template and search windows, a total of 81 cross correlation coefficients are computed. These 81 coefficients are actually in the form of a 9x9 matrix which correspond to the overlap positions of the template upon the window. The maximum coefficient in this sample is assumed to be the best representation for a true match. This coefficient must now pass the probability criterion of 1% which can be thought of as a confidence criterion of 99%. It is clear from the discussion in §2 that additional criteria are needed in this step to insure a significant correlation has been found.
7. If the coefficient passes the confidence criterion, the position of the match in geometrically corrected space must now be determined to sub-pixel accuracy. In the field of 81 correlation coefficients, the only coefficients (or more properly the corresponding coordinates) included in the match position computation are those that fulfill a series of criteria which are still being tested. It is quite important to determine accurately the position of best match as the signal-to-noise ratio dramatically decreases with even a misregistration of 0.2 pixels (Oliver 1979).
8. If a successful match has not been found, a different template in the local neighborhood is chosen and the program returns to Step 3. After nine unsuccessful tries in

the area, the program goes on to the next sample.

IV Application of the Algorithm to IUE Images

The current algorithm has been tested under limited conditions on actual IUE images. Because some of the critical parameters (necessary threshold values and success criteria) still need to be explored, more exhaustive tests are planned for the near future. Completed tests are described in the following text.

a) *Identity Test*

This initial test compared a single raw UV Flood image, LWR9177R, with itself. The main goal was to be able to run the program to completion, verify all portions of the code performed as expected, and reveal deficiencies in the algorithm. Coordinates for the pattern matching are the same in both images and define the centers of the template and window boxes. Since this comparison is actually an autocorrelation, it was hoped that an acceptable correlation would be present in all cases. Moreover, the accurate position of the maximum correlation coefficient should be found precisely at the central coordinates of the window.

Figure 7 displays the results of this test. Isolated points represent positions where the sub-arrays from the two images were selected for pattern matching, but did not achieve a successful match. Boxes represent positions where a successful correlation was found. Lines emanating from the boxes denote the magnitude and direction of any change in position from the first image to the second image. The vectors have been magnified for visual clarity by a factor of 50 in this figure; the directions and relative sizes of the vectors are correct. A box which has no corresponding vector denotes a successful match found at the same position in the two images. Indeed, 100% of the samples chosen were determined to be successful according to the 1% probability criterion (or the 99% confidence level). However, the positions of maximum correlation implied shifts which are *known* to be incorrect. The peak of the cross correlation matrix is, in fact, always correct for this test with maximum correlation coefficients of +1.0. Problems arise when determining the match position to sub-pixel accuracy. The average shift calculated for all of the samples in this comparison was 0.21 pixels. Oliver (1979) showed that even a misregistration of 0.2 pixels substantially decreases the signal-to-noise ratio in the photometrically corrected image. The current position determination algorithm may be inadequate to find the coordinates of the match with the desired sub-pixel accuracy. However, due to statistics and the presence of noise in the data, spurious correlations will be found and can be confused with the genuine correlation peak. The consequence of this can be large and/or inconsistent looking shifts. Figure 8 displays the distributions of match position in both Sample and Line. Out of 996 samples, approximately 70% of the matches were found within 0.05 pixels of zero (no shift).

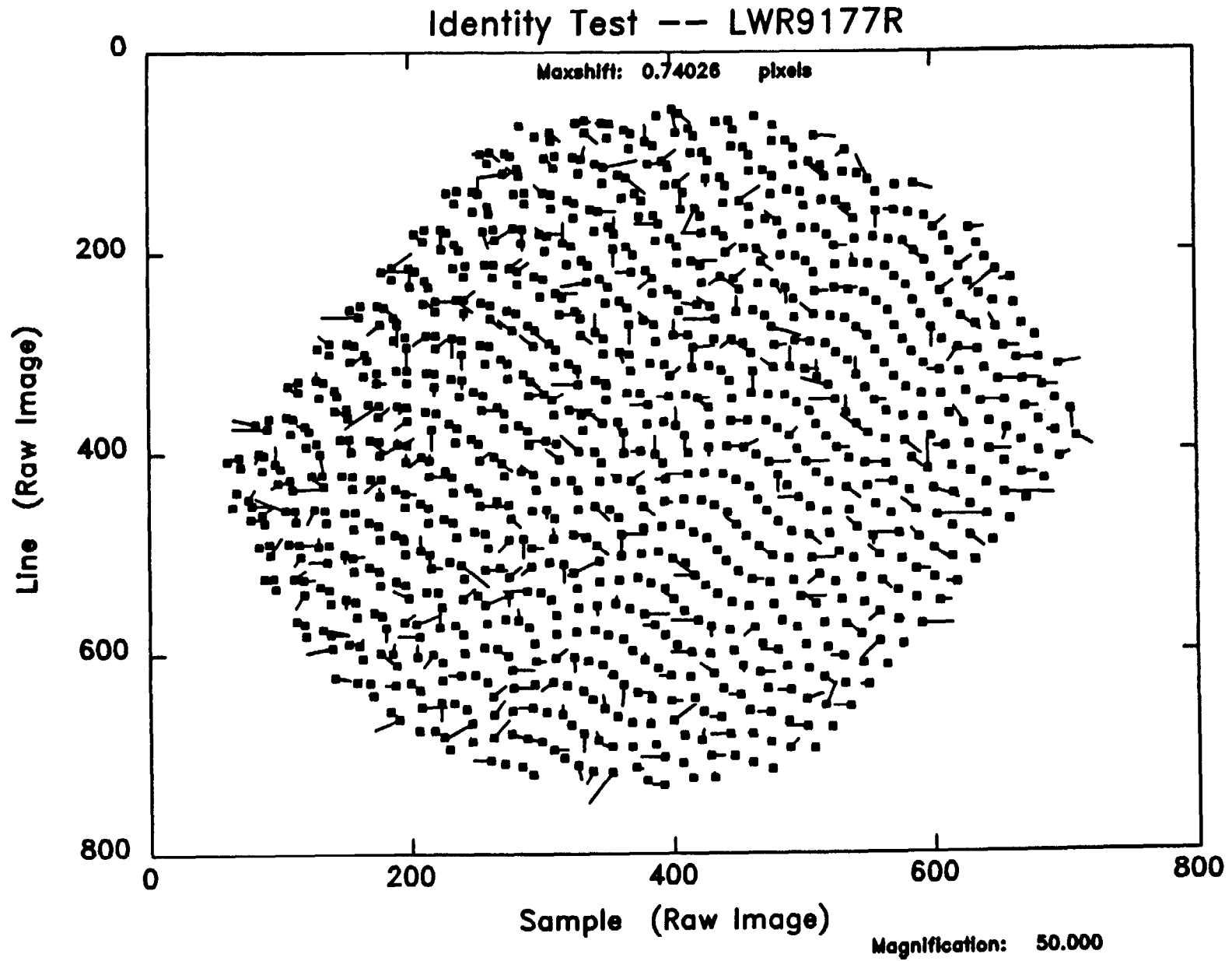

Figure 7: Results of the Identity Test - An autocorrelation performed with LWR9177R.

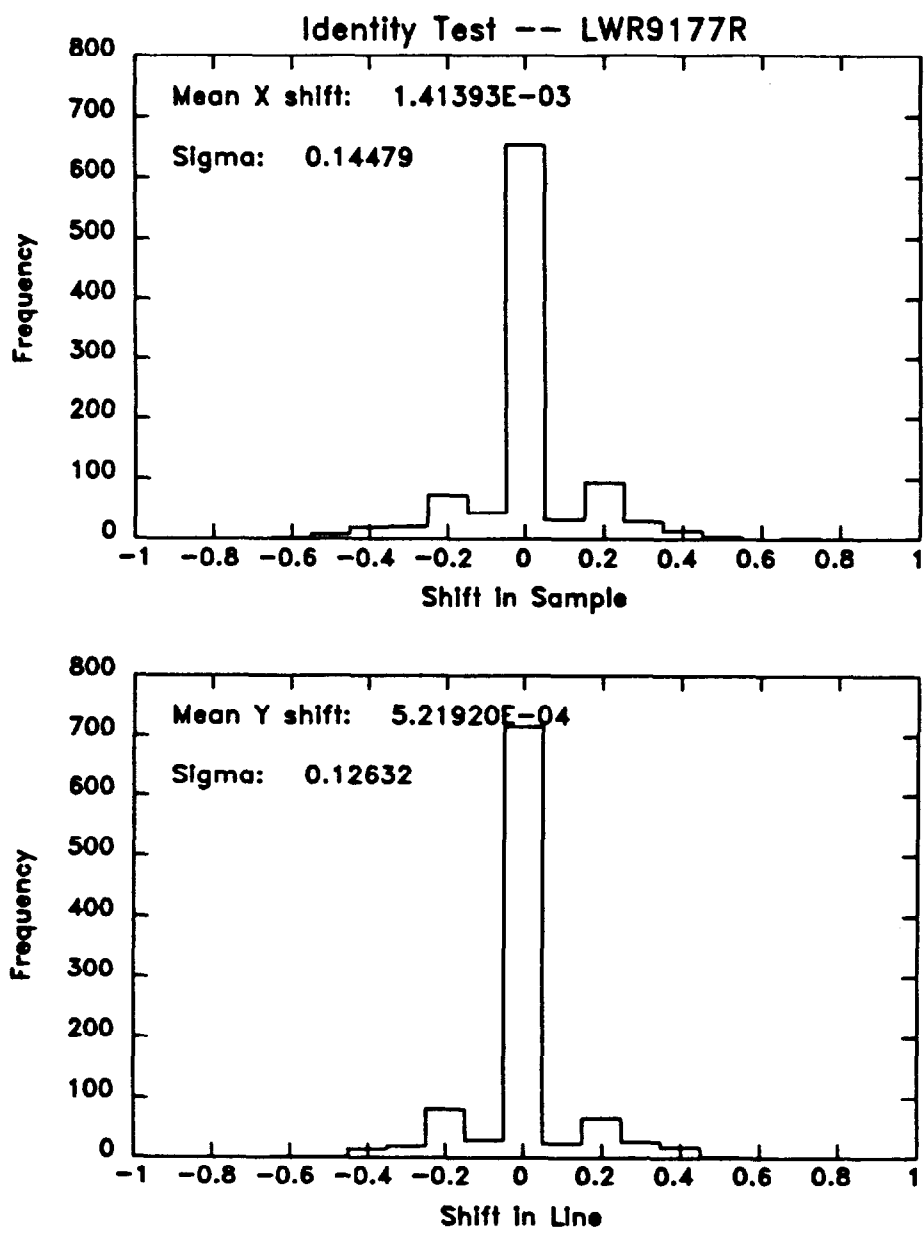

Figure 8: Distributions of correlation positions in Sample (upper) and Line (lower).

b) *Raw to Raw Comparison Test*

For the next test, the input images were two, raw flat field exposures, LWR9177R and LWR9180R, which had been taken within a few hours of each other, had approximately the same temperature, and had nearly the same background DN level. This is an ideal test for finding fixed pattern since the pattern will not have had an opportunity to change in time, the physical situations are similar, and the noise levels are about the same. Moreover, several parameters (window contrast and variance, and cross correlation contrast and variance) are being computed for possible use as additional success criteria.

As in the identity test, coordinates for the pattern matching are the same in both images and define the centers of the template and window boxes. Hence, if there were no change in the pattern and the position of the pattern between the two images, the template will match the window in the central position, yielding no shift vector.

In the 996 samples chosen, 100% of the samples satisfied the 99% confidence test. Figure 9 displays the results of this test. Due to the idealized conditions of this comparison test, one might expect the patterns to be found in the same positions in the two raw images as determined by the pattern matching program. As in the identity test, the computed position associated with the maximum correlation coefficient seems to be inaccurate and unreliable. The largest shifts in position are located mostly in the lower left corner of the target area. This particular portion of the target area is known to be relatively smooth, making the current pattern matching algorithm less reliable. This smooth region is present in all of the cameras. Unfortunately, the nature of the smoothing is unknown at this time.

Figure 10 represents the cross correlation coefficients computed for the successful match positions for this test. Recall currently the only criterion for a successful match is the cross correlation coefficient must pass the 1% probability test. Specific values of the coefficients that pass this criterion can vary, depending upon the number of data points used to derive the coefficient; the number of data points can range from a minimum of 31 to a maximum of 63 with the typical number of points being 61. In general Figure 10 shows that the region of the camera with the lowest acceptable correlation coefficients (weaker correlations) is the lower left hand corner where the camera appears to be smoother.

c) *Raw to Random Comparison Test*

A raw UV Flood image, LWR9177R, and a random number generated image superimposed with gaussian noise were compared as a control for the previous results. As no true matches were expected, the purpose of this test was to determine the conditions under which pattern matches should not be found.

Out of 996 samples, 922 (93%) correlations passed the 1% probability test (99% confidence test). The reason for the numerous matches can be understood by recalling the results presented in Table 1. For the 1% probability criterion, approximately 1% spurious matches can be found due purely to statistics. For each sample (template and window combination), 81 correlation coefficients are determined. Recall if a successful match is

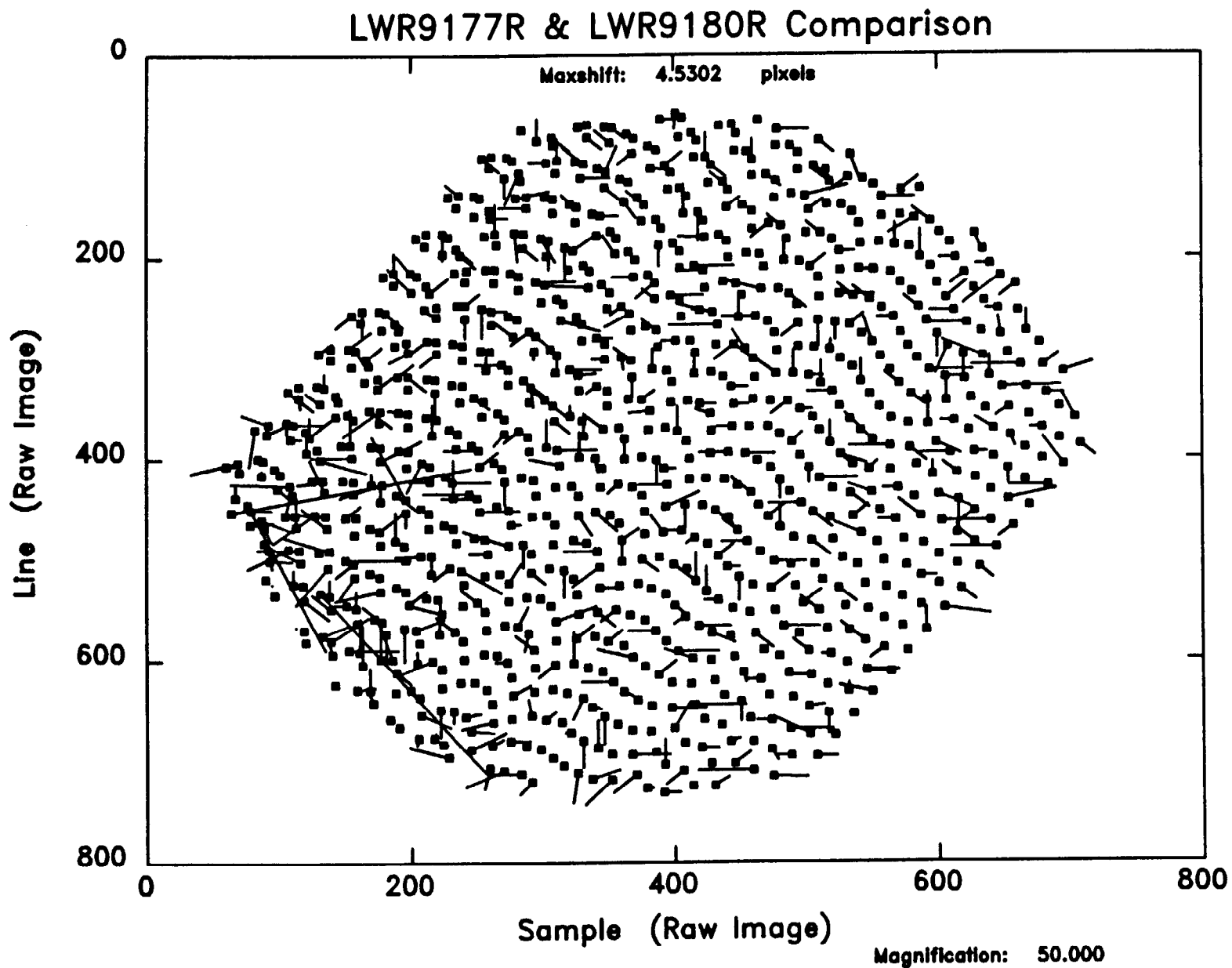

Figure 9: Results of the Raw to Raw Comparison Test - Two, raw flat field images, LWR9177R and LWR9180R.

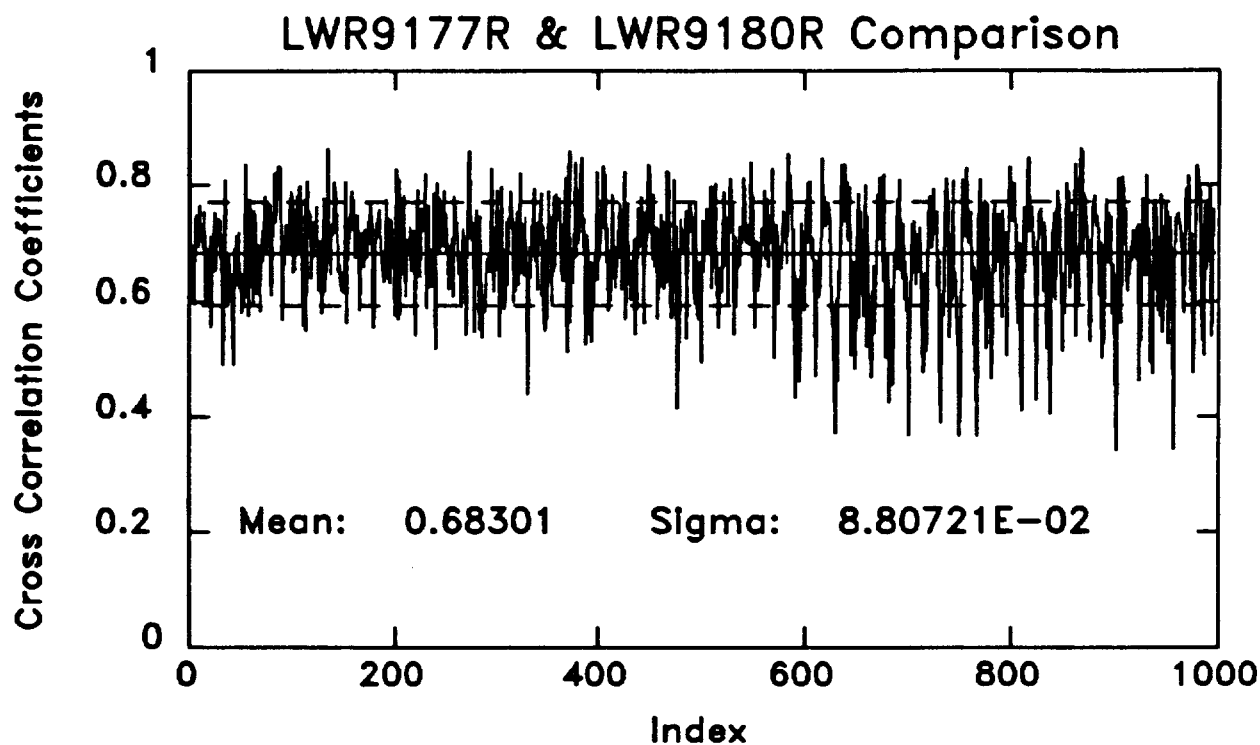

Figure 10: Cross Correlation Coefficients for the successful match positions computed for the Raw to Raw Comparison Test. In this plot, the data points are connected by a solid line; the mean is a solid horizontal line; and one sigma is denoted by the dashed horizontal lines. The x-axis represents the Index or number of the current template/window combination. In the reference frame of an image, the Index runs from the upper right edge of the target area to the lower left edge.

not found among the 81 coefficients, the algorithm allows a new template (and corresponding window) displaced and distinct from the original to be chosen, and 81 new coefficients are calculated. This can be repeated for a total of nine times, computing a possible 729 correlation coefficients for one specified region. Because of the way the algorithm is currently designed, there exists the opportunity of finding a spurious pattern "match" at every proposed sample position. Figure 11 displays the results of this test. It is known *a priori* there are no real matches to be found between these two images, and the character of the displacement vectors displays no consistent relationship. Although there is no reason at this time to believe the small corrections to the current geometric correction found through pattern matching would not display such seemingly inconsistent behavior, there must be a definitive way to distinguish between genuine and spurious matches. It is quite clear that the criteria need to be supplemented to filter the spurious correlations.

The motivation for allowing additional chances for pattern matching can be explained by noting the smoothed character of the geometrically corrected images. Currently, in order to determine the mapping of any pixel from geometrically corrected space to raw space, a bilinear interpolation is computed for the specific pixel, using information from the four surrounding reseaux. The bilinear interpolation introduces a fair amount of non-uniform smoothing into the resultant image (zebra stripe pattern). Smooth regions reduce the chances for successful pattern matches and as there is no predictable way to determine the coordinates of the smoothed areas, the additional chances are allowed so that a template and window combination in a sharper region can be utilized. These additional chances will probably be eliminated in future versions of the algorithm because of the inconsistency in the match criteria. Moreover, new interpolation schemes for the geometric mapping have been explored (i.e. spline) which produce a higher quality (less smooth) resultant image, and for the most part, eliminate the smoothed streaks seen in the geometrically corrected images.

Figure 12 presents the correlation coefficients computed for all the successful pattern matches in this test. Individual correlation coefficients in this plot are distinctly lower than those seen in Figure 10.

d) *Raw Spectral to ITF Comparison Test*

The final test performed utilized a raw spectral image (LWR9684R) and an average of the first and second ITF levels. This averaged ITF image had the same mean background DN level as the mean background in the spectral image. Out of a possible 997 samples, 992 (99%) samples passed the 1% probability test (99% confidence test). Figure 13 displays the results of this test. In contrast to the earlier plots of the type, the vectors shown here denote the deviations from the current geometrically corrected coordinates to a new geometrically corrected position determined with the fixed pattern matching.

The region on this plot enclosed within the dashed rectangle contains those portions of the LWR camera that were analyzed by the Lund group. For the most part, this entire

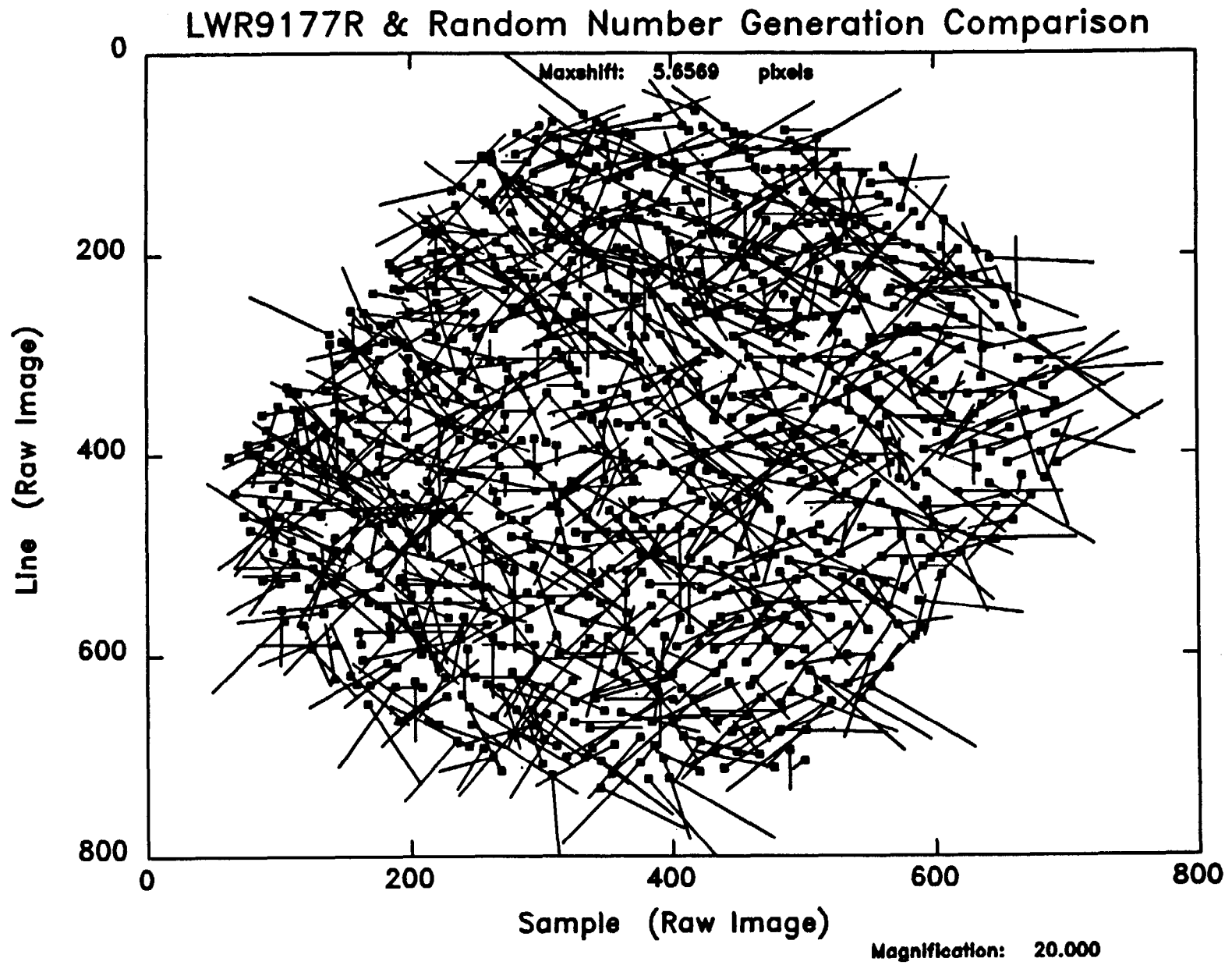

Figure 11: Results of the Raw to Random Comparison Test - Raw flat field image, LWR9177R, and a Random Number Generated Image.

LWR9177R & Random Generated Image Comparison

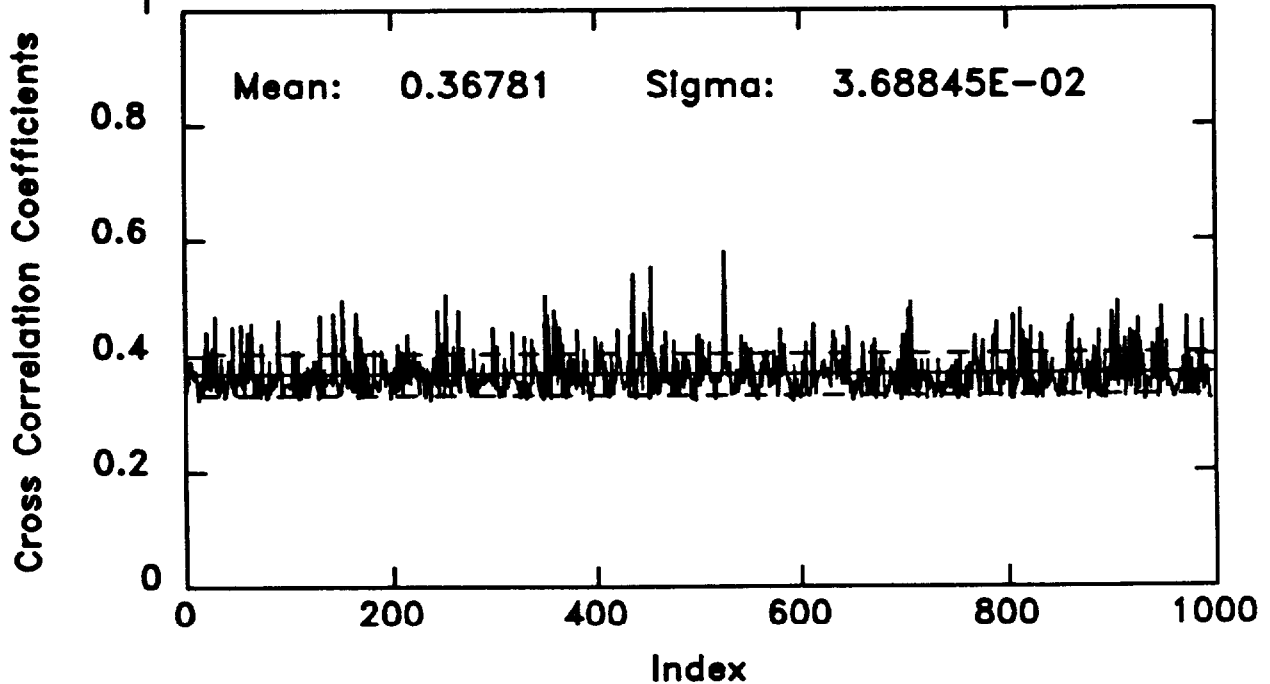

Figure 12: Cross Correlation Coefficients for the successful match positions computed for the Raw (LWR9177R) to Random Comparison Test. Data points are connected by a solid line; the mean is a solid horizontal line; and one sigma is denoted by the dashed horizontal lines.

region displays consistent shifts for the fixed pattern. An average shift in this area is about 0.97 pixels. Figure 14 displays the correlation coefficients computed for this test. The correlation coefficients which specifically correspond to the region analyzed by the Lund group are enclosed within the dashed rectangle in Figure 14. Since the fixed pattern matching is just a fine tuning to the current geometric correction, it is not known at this time if the small deviation vectors should display consistent behavior or appear to move in apparently random directions. If indeed the true small deviation vectors display inconsistent behavior, the algorithm must be capable of distinguishing between apparently random vectors and those produced by the Raw to Random Comparison Test. At this time, a definitive way to differentiate true matches from spurious statistical matches in a reliable fashion has not been found.

V Conclusions

It is desirable to choose a probability criterion for the correlation coefficients which allows the optimum retention of the genuine correlations such that a sufficient number of fiducials can be utilized to produce a finer raw-to-geometric mapping than is currently implemented. It will be necessary for the fiducials to pass through a filtering process to remove likely spurious correlations which will be present regardless of the criterion adopted. As a consequence, useful information is not discarded due to too rigid constraints.

The following set of conclusions can be drawn from the results of the completed tests.

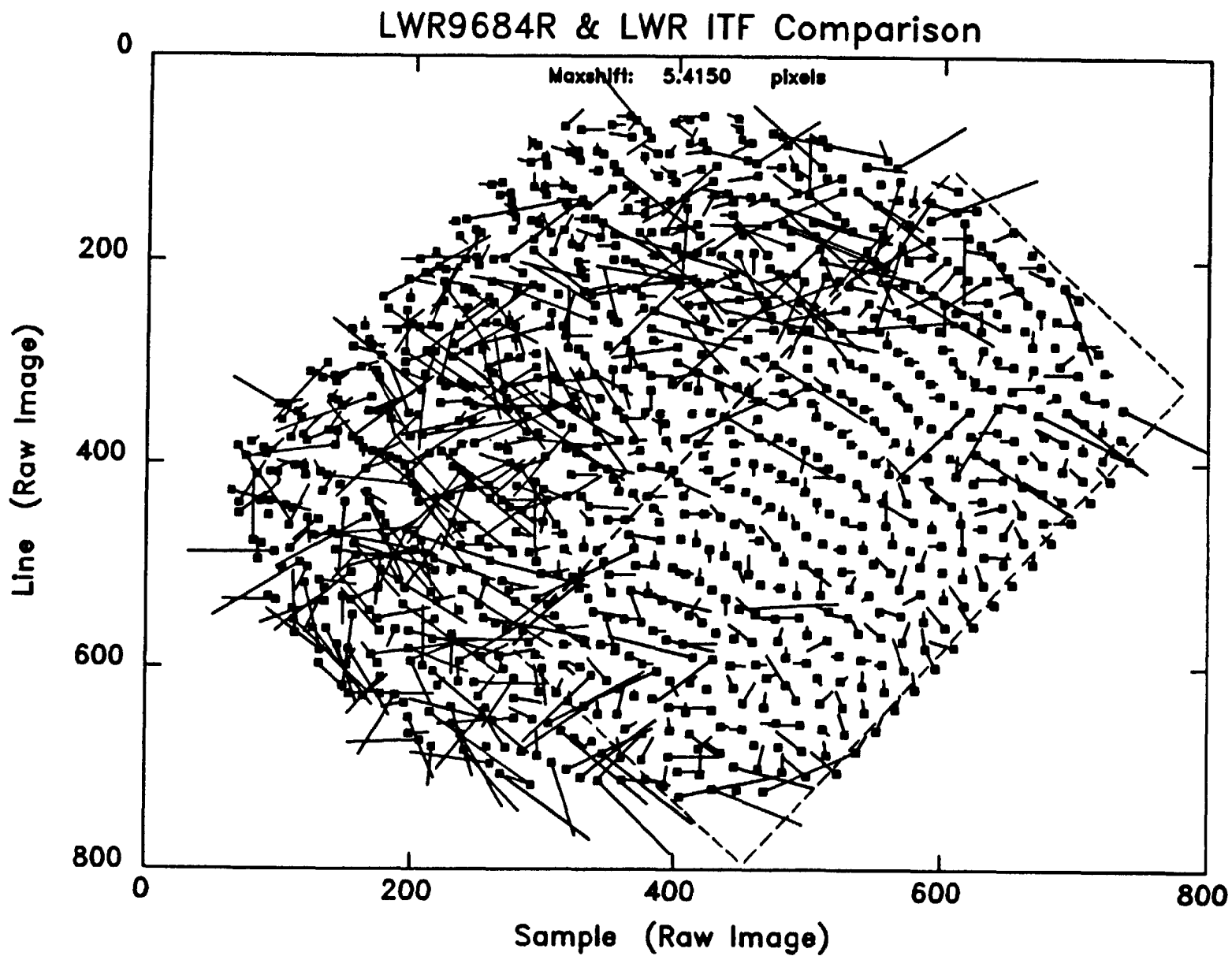

Figure 13: Results of the Spectral to ITF Comparison Test - Raw, high resolution spectral image (LWR9684R) and an LWRITF image.

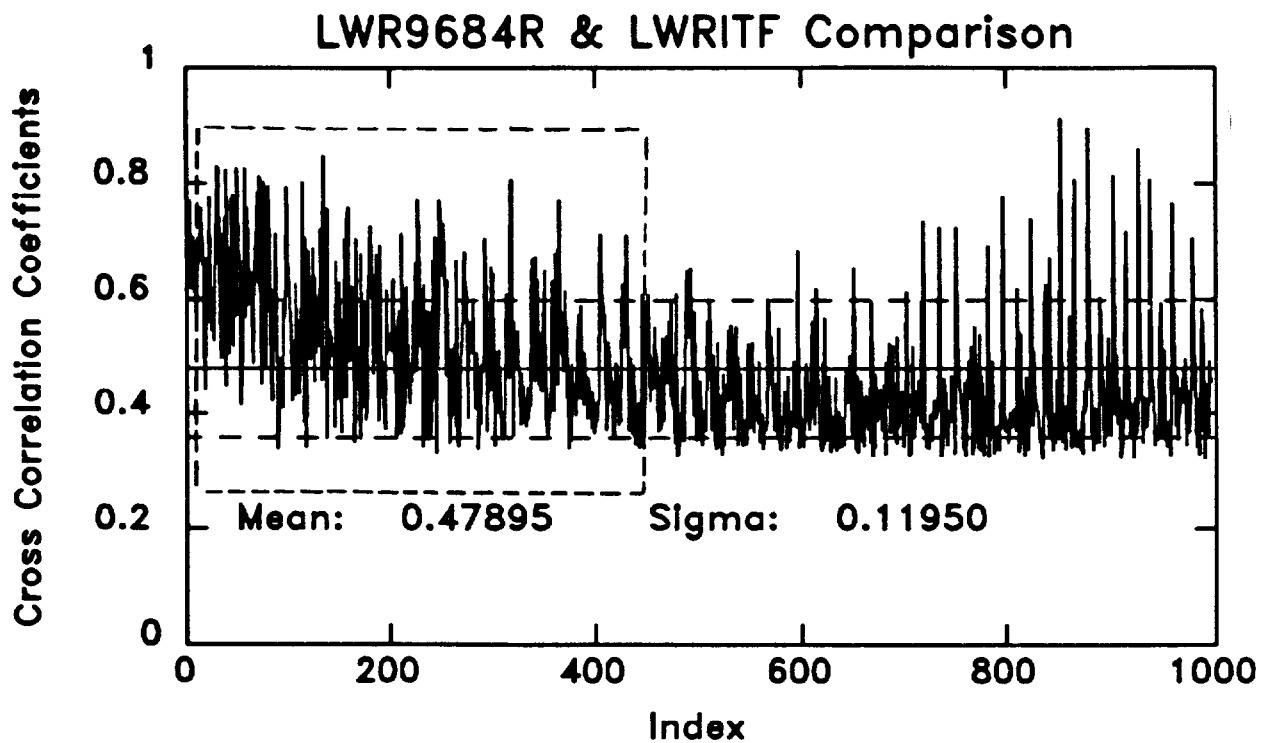

Figure 14: Cross Correlation Coefficients for the successful match positions computed for the Spectral to ITF Comparison Test.

1. In general, the cross correlation seems to be able to detect genuine pattern matches though problems arise in regions of a low signal-to-noise ratio. This positive result, though it may be limited, indicates further analysis could yield promising algorithms for the improvement of the geometric correction.
2. Considering the results of the pattern matching tests of Section 2.3.2 where known patterns were imposed upon background information with noise, the linear cross correlation function may not be sensitive enough to reliably detect pattern matches in all the situations that will arise as a consequence of the diversity of the IUE dataset. Therefore, more rigorous pattern matching mechanisms should be explored which can optimize the rate of pattern matches. Results from any new methods should be compared to similar results produced by the cross correlation function.
3. The inevitable spurious detections can cause the algorithm to find a "true" match when there is not one present, and therefore, a reliable method of filtering the spurious matches must be found.
4. The probability distribution is a necessary, but insufficient criterion in evaluating the cross correlation coefficient for determining true pattern matches in this particular application. Additional criteria need to be found which can definitively determine a true pattern match. Some of the additional criteria being considered for use are: the variance in the cross correlation matrix, the variance in the window sample, and the comparison of the mapping of a particular fiducial with the mappings produced by the nearest neighbors.

5. Since this method provides a fine tuning to the current geometric mapping, the shifts should be small. In analyses of reseaux displacements, the reseaux are seen to move a maximum of 1.5 pixels under the most extreme temperature ranges to date. The current template and window sizes allow for a maximum of a $+/- 4$ pixel shift in both the line and sample directions. Reducing the size of the search window could eliminate spurious matches and reduce computation time.

The conditions under which the algorithm produces a useful set of fixed pattern fiducials must be well defined. These conditions can range from the ideal case of being applicable to all IUE images, to the worst case of being useful only to a very select set of data.

If a concise algorithm for the pattern matching technique can be defined, it must still be seriously considered whether any improvement to the geometric correction is significant enough and global enough to warrant the inclusion of the algorithm in the production processing for the final IUE archive. If the pattern matching algorithm does not prove to be a viable technique for a significant portion of the IUE images, the algorithm may still warrant further development for use in the Regional Data Analysis Facilities (RDAFs). Users would then have the ability to tailor the technique to suit the specific research requirements. Further testing and analysis of the current algorithm is proceeding, as well as the exploration into more rigorous techniques of pattern matching.

REFERENCES

- Bevington, P.R. 1969, *Error Analysis for the Physical Sciences*, (New York: McGraw-Hill Book Company).
- Gonzalez, R.C., and Wintz, P. 1987, *Digital Image Processing*, (Massachusetts: Addison-Wesley Publishing Company).
- Linde, P., and Dravins, D. 1988 *IUE ESA Newsletter*, **29**, 9.
- Linde, P., and Dravins, D. 1988 *Video and accompanying text*, unpublished information.
- Oliver, M. 1979, *IUE Technical Report*, No. 45.
- Press, W.H., Flannery, B.P., Teukolsky, S.A., and Vetterling, W.T. 1986, *Numerical Recipes*, (Cambridge: Cambridge University Press).
- Taylor, J.R. 1982, *An Introduction to Error Analysis*, (California: University Science Books).
- Turnrose, B.E., and Thompson, R.W. 1984, *International Ultraviolet Explorer Image Processing Information Manual, Version 2.0*, (Computer Sciences Corporation, CSC/TM-84/6058).